

Varenummer: 203380M24200B1T
 Beskrivelse: E+G Justerfod
 GN 33-80-M24-200-B1-T, Rustfast
 Note: T Uden møtrik, spændeflade i bunden

Mål

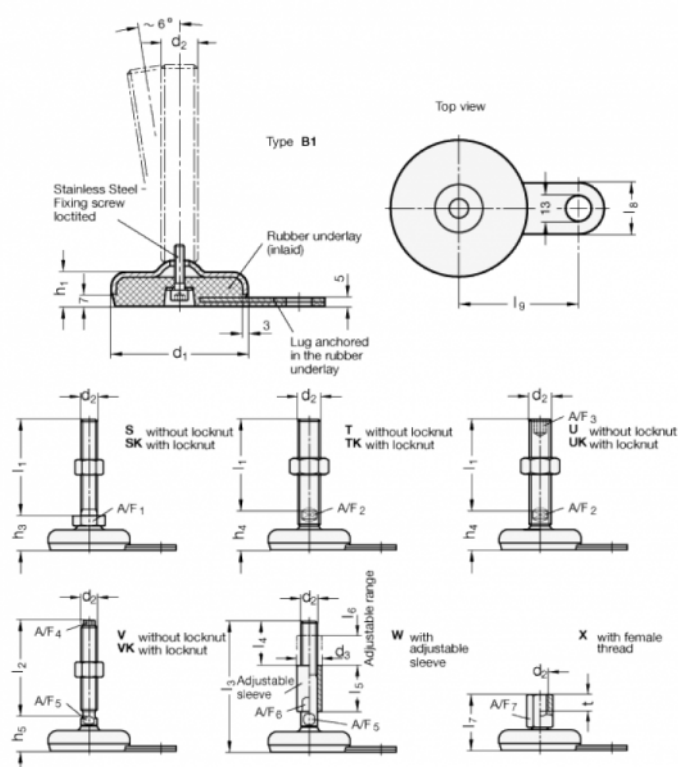

A/F2 = 19
 d1 = 80
 d2 = M24
 h1 = 20
 h4 = 38
 l1 = 200
 l8 = 30
 l9 = 70